

Doro 3500

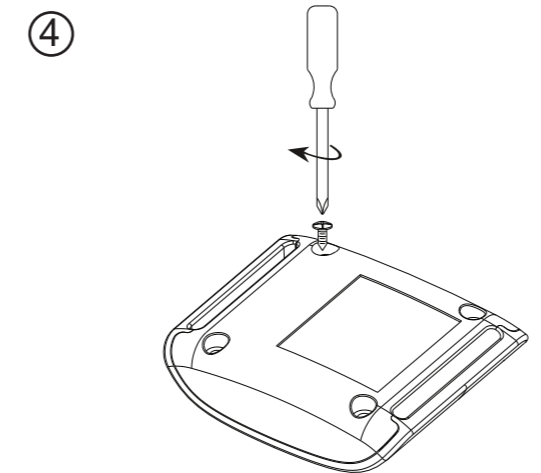

Doro 3500
Version 1.0
©2016. All rights reserved.
www.doro.com

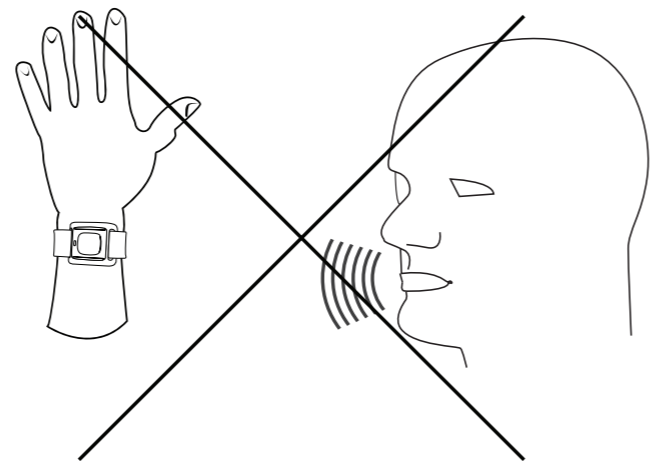
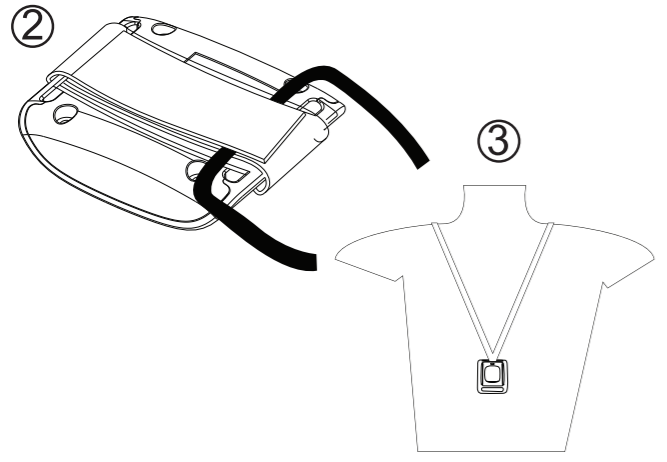
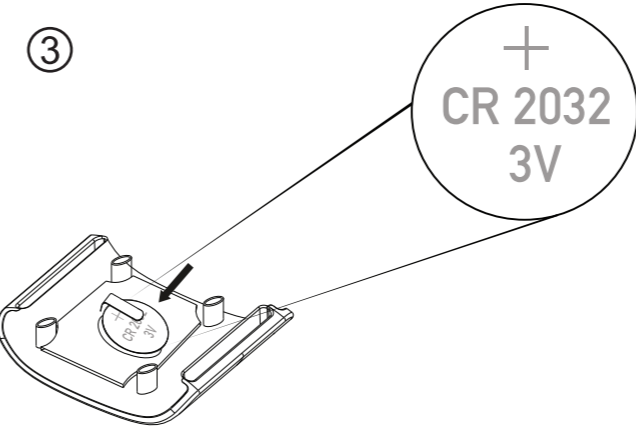
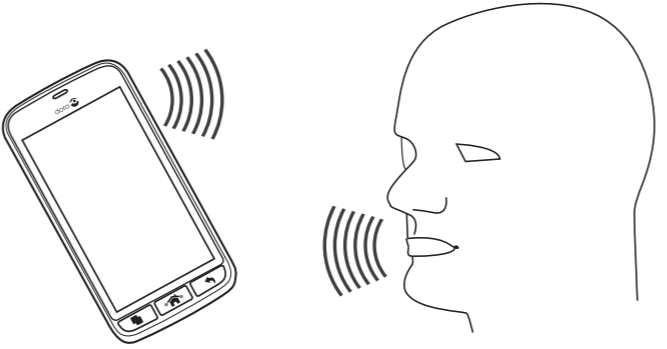
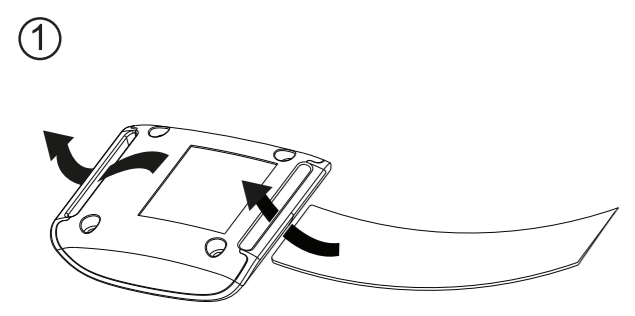
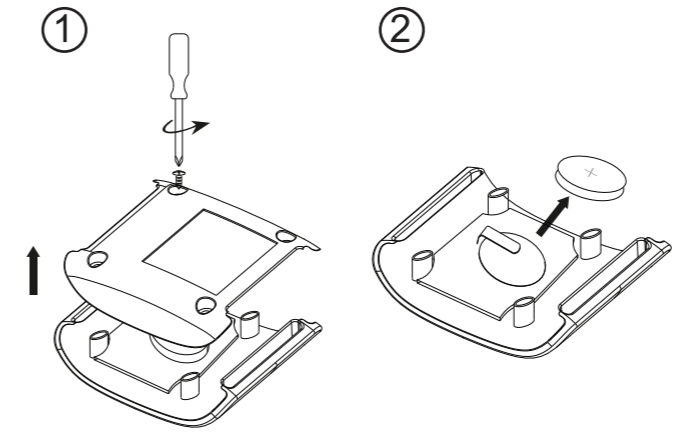
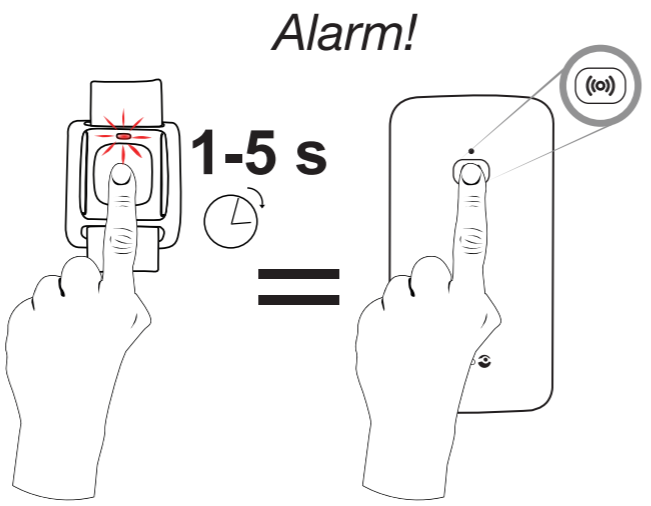
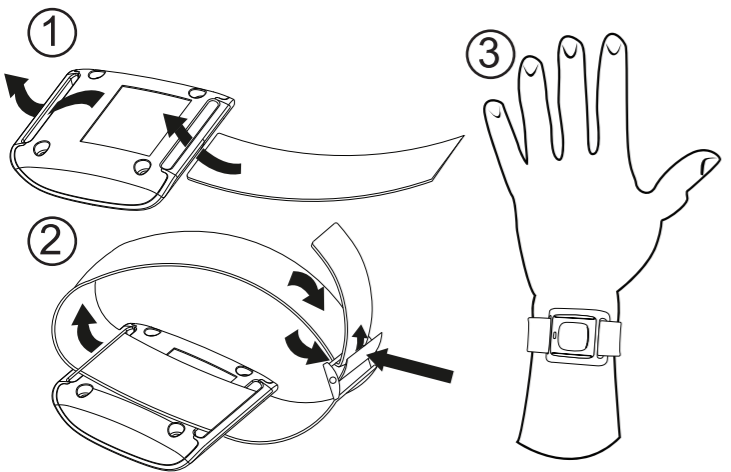
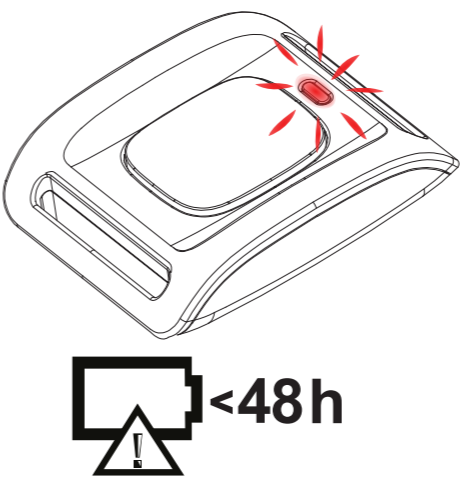
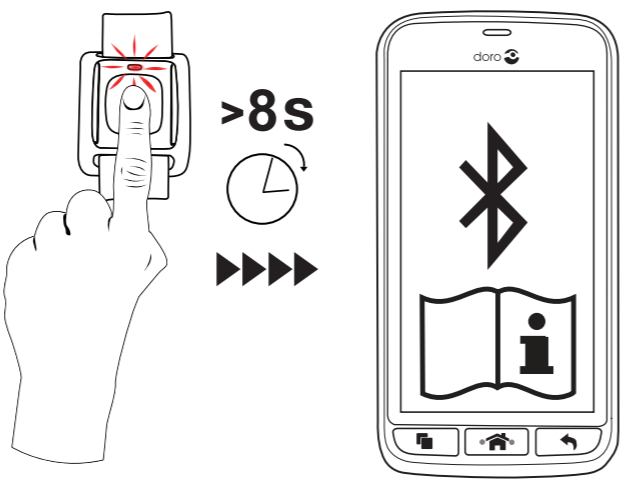

ENGLISH

EC Declaration of confirmation

Hereby Doro AB declares that this equipment is in compliance with Directive 1999/5/EC (R&TTE) and 2011/65/EU (RoHS). The full text of the EU declaration of conformity is available at the following internet address: www.doro.com/dofc

Product information

This product is a part of a social alarm system intended to initiate a call in case of emergency or if assistance is needed. It is intended for indoor use in a home environment.

Frequency band: Bluetooth® 2.4-2.4835 GHz, Radio-frequency power: max. 2.5mW (4dBm)

Safety information

- The unit is splash water proof, but must never be submerged in water.
- Keep the unit clean and dry to prevent skin irritations.
- Battery replacement may be performed in accordance with the instructions. Only use recommended battery type as stated in this manual. CAUTION – Risk of explosion if battery is replaced by an incorrect type. Dispose of used batteries according to the instructions.

Environmental information

 This product complies with the requirements of the EU directive 2006/66/EC (Batteries) and 2012/19/EU (WEEE) and should not be disposed of with other household waste.

Always recycle your used electronic products, batteries, and packaging materials to dedicated collection points.

Doro AB is a Swedish mobile phone manufacturer. The company was founded in 1989, and is currently owned by the private equity company Permira. Doro AB is a public company listed on the Stockholm Stock Exchange. The company's headquarters are located in the city of Örebro, Sweden. Doro AB is a leading manufacturer of mobile phones in the Nordic region. The company's products are sold in over 100 countries. Doro AB is a member of the Mobile Manufacturers Forum (MMF).

FRANÇAIS

Déclaration de conformité CE

Par la présente, Doro AB déclare que cet équipement est conforme aux exigences des directives 1999/5/CE (R&TTE) et 2011/65/UE (RoHS). Le texte intégral de la déclaration de conformité UE est disponible à l’adresse Internet suivante : www.doro.com/dofc

Information produit

Ce produit fait partie d’un système de téléassistance destiné à émettre un appel en cas d’urgence ou de demande d’assistance. Il est destiné à un usage intérieur au sein d’une habitation.

Plage de fréquence : Bluetooth® 2,4-2,4835 GHz, puissance radioélectrique : 2,5 mW (4 dBm) max.

Information de sécurité

- L'appareil est étanche aux éclaboussures mais ne doit jamais être immergé dans l'eau.
- S'assurer que l'appareil demeure propre et sec pour prévenir les irritations de la peau.
- Le remplacement des batteries doit être effectué selon les instructions. Utiliser uniquement le type de batteries indiqué dans ce manuel. ATTENTION - Risque d’explosion si la batterie est remplacée par un type de batterie incorrect. Jeter les batteries usagées en respectant les réglementations en vigueur.

Information environnementale

 Ce produit est conforme aux exigences des directives de l’Union européenne 2006/66/CE (batteries) et 2012/19/UE (DEEE) et ne doit pas être mis au rebut avec d’autres déchets ménagers.

Veillez à toujours recycler vos produits électroniques, batteries et matériaux d’emballage usagés dans les points de collecte dédiés.

Doro AB is a Swedish mobile phone manufacturer. The company was founded in 1989, and is currently owned by the private equity company Permira. Doro AB is a public company listed on the Stockholm Stock Exchange. The company's headquarters are located in the city of Örebro, Sweden. Doro AB is a leading manufacturer of mobile phones in the Nordic region. The company's products are sold in over 100 countries. Doro AB is a member of the Mobile Manufacturers Forum (MMF).

DEUTSCH

EU-Konformitätserklärung

Hiermit erklärt Doro AB, dass dieses Gerät den Richtlinien 1999/5/EG (R&TTE) und 2011/65/EG (RoHS) entspricht. Der vollständige Text der EU-Konformitätserklärung ist unter folgender URL verfügbar: www.doro.com/dofc

Produktinformationen

Dieses Produkt ist Teil eines Hausnotrufsystems, das im Notfall, oder wenn Hilfe benötigt wird, einen Hilferuf absetzt. Es ist nicht für den Einsatz in Innenräumen in privaten Haushalten vorgesehen.

Frequenzbereich: Bluetooth® 2,4-2,4835 GHz, Hochfrequenzleistung: Max. 2,5 mW (4,0 dBm)

Sicherheitshinweise

- Das Gerät ist nur spritzwassergeschützt, d. h., es darf nie in Wasser eingetaucht werden.
- Halten Sie das Gerät sauber und trocken, um Hautirritationen zu vermeiden.
- Der Austausch der Batterien darf nur gemäß der Anleitung durchgeführt werden. Nur empfohlene Batterietypen verwenden, so wie in diesem Handbuch angegeben. ACHTUNG – Wird ein falscher Akkutyp eingelegt, besteht Explosionsgefahr! Entsorgen Sie die alten Akkus entsprechend den örtlichen Vorgaben.

Umweltinformationen

 Dieses Produkt entspricht den Anforderungen aus den EU-Richtlinien 2006/66/EG (Batterien) und 2012/19/EU (WEEE) und darf nicht in den Hausmüll gegeben werden. Führen Sie gebrauchte elektronische Produkte, Batterien, Akkus und Verpackungsmaterial stets dem Recycling bei den zuständigen Sammelstellen zu.

Doro AB is a Swedish mobile phone manufacturer. The company was founded in 1989, and is currently owned by the private equity company Permira. Doro AB is a public company listed on the Stockholm Stock Exchange. The company's headquarters are located in the city of Örebro, Sweden. Doro AB is a leading manufacturer of mobile phones in the Nordic region. The company's products are sold in over 100 countries. Doro AB is a member of the Mobile Manufacturers Forum (MMF).

ESPAÑOL

Declaración de conformidad CE

Por la presente, Doro AB declara que este equipo cumple lo establecido en las Directivas 1999/5/CE (R&TTE) y 2011/65/UE (RoHS). El texto completo de la Declaración de conformidad UE está disponible en la siguiente dirección de Internet: www.doro.com/dofc

Información del producto

Este producto forma parte de un sistema de alarma social cuya finalidad es iniciar una llamada en caso de que se produzca una emergencia o de que se necesite asistencia. Está pensado para su uso en interiores, en un entorno doméstico.

Banda de frecuencia: Bluetooth® 2,4–2,4835 GHz, potencia de radiofrecuencia: máx. 2,5 mW (4 dBm)

Información sobre seguridad

- La unidad es resistente a salpicaduras, pero nunca se debe sumergir en agua.
- Mantenga la unidad limpia y seca para evitar irritaciones cutáneas.
- La sustitución de las baterías solo se debe realizar de acuerdo con las instrucciones. Utilice única- mente el tipo de batería recomendado en este manual. PRECAUCIÓN: existe riesgo de explosión si cambia las baterías por un modelo incorrecto. Deseche las baterías usadas según las instrucciones.

Información medioambiental

 Este producto cumple las exigencias establecidas en la Directiva UE 2006/66/CE (Baterías) y 2012/19/EU (RAEE), y no debe desecharse con el resto de los residuos domésticos.

Recicle siempre los productos electrónicos, baterías y materiales de embalaje utilizados llevándolos a los puntos de recogida correspondientes.

ITALIANO

Dichiarazione di conformità CE

Doro AB dichiara con la presente che la presente apparecchiatura è conforme alle Direttive 1999/5/CE (R&TTE) e 2011/65/UE (RoHS). Il testo integrale della Dichiarazione di conformità CE è disponibile al seguente indirizzo Internet: www.doro.com/dofc

Informazioni sul prodotto

Questo prodotto è parte di un sistema di allarme sociale, progettato per effettuare chiamate di emergenza o per richiedere assistenza. L'apparecchiatura è pensata per l'uso in interni in ambiente domestico.

Banda di frequenze: Bluetooth® 2,4–2,4835 GHz, potenza della frequenza radio: max. 2,5 mW (4 dBm)

Informazioni sulla sicurezza

- L'unità è resistente agli schizzi, ma non deve essere in alcun caso immersa in acqua.
- Conservare l'unità pulita e asciutta per evitare irritazioni cutanee.
- La sostituzione delle batterie deve essere effettuata in conformità alle istruzioni. Usare unicamente il tipo di batteria indicato nel presente manuale. ATTENZIONE: l'uso di un tipo di batteria non corretto comporta un rischio di esplosione. Smaltire le batterie usate secondo le istruzioni.

Informazioni ambientali

 Il presente prodotto è conforme alla Direttiva 2006/66/CE (Batterie) e alla Direttiva 2012/19/UE (RAEE) e non deve essere smaltito insieme ai normali rifiuti domestici.

Riciclare sempre i prodotti elettronici usati, le batterie esaurite e gli imballaggi non più necessari presso i punti di raccolta appositi.

Doro AB is a Swedish mobile phone manufacturer. The company was founded in 1989, and is currently owned by the private equity company Permira. Doro AB is a public company listed on the Stockholm Stock Exchange. The company's headquarters are located in the city of Örebro, Sweden. Doro AB is a leading manufacturer of mobile phones in the Nordic region. The company's products are sold in over 100 countries. Doro AB is a member of the Mobile Manufacturers Forum (MMF).

NEDERLANDS

EG-conformiteitsverklaring

Hierbij verklaart Doro AB dat deze apparatuur in overeenstemming is met Richtlijn 1999/5/EG (R&TTE) en 2011/65/EU (RoHS). De volledige tekst van de EU-conformiteitsverklaring is te vinden op het volgende internetadres: www.doro.com/dofc

Productinformatie

Dit product is deel van een sociaal-alarmsysteem bestemd om in een noodsituatie of als er hulp vereist is een oproep te doen uitgaan. Het is bestemd voor binnengebruik in een woonomgeving.

Frequentieband: Bluetooth® 2,4-2,4835 GHz, Radiofrequent-vermogen: max. 2,5 mW (4 dBm)

Veiligheidsinformatie

- De eenheid is spatwaterdicht, maar mag nooit in water worden ondergedompeld.
- Houd de eenheid schoon en droog om huidirritatie te voorkomen.
- De batterijen mogen uitsluitend in overeenstemming met de instructies worden vervangen. Gebruik uitsluitend het aanbevolen type batterijen dat in deze handleiding wordt vermeld. VOORZICHTIG – Er is ontploffingsgevaar als de batterij wordt vervangen door een verkeerd type. Voer gebruikte batterijen af volgens de instructies.

Milieu-informatie

 Dit product voldoet aan de eisen van EU-richtlijn 2006/66/EG (Batterijen en accu's) en 2012/19/EU (AEEA) en mag niet met het normale huishoudelijke afval worden weggegooid.

Recycle altijd uw gebruikte elektronische producten, batterijen en verpakkingsmaterialen door ze naar speciale inzamelpunten te brengen.

Doro AB is a Swedish mobile phone manufacturer. The company was founded in 1989, and is currently owned by the private equity company Permira. Doro AB is a public company listed on the Stockholm Stock Exchange. The company's headquarters are located in the city of Örebro, Sweden. Doro AB is a leading manufacturer of mobile phones in the Nordic region. The company's products are sold in over 100 countries. Doro AB is a member of the Mobile Manufacturers Forum (MMF).

DANSK

EU-overensstemmelseserklæring

Doro AB erklærer hermed, at dette udstyr er i overensstemmelse med direktiverne 1999/5/EF (R&TTE) og 2011/65/EU (RoHS). EU-overensstemmelseserklæringens fulde ordlyd kan læses på følgende internetadresse: www.doro.com/dofc

Produktoplysninger

Dette produkt er en del af et socialt alarmsystem, der er beregnet til at foretage et opkald, hvis der opstår en nødsituation, eller hvis der er behov for assistance. Det er beregnet til indendørs anvendelse i boliger.

Frekvensbånd: Bluetooth® 2,4-2,4835 GHz, radiofrekvenseffekt: maks. 2,5 mW (4 dBm)

Sikkerhedsinformation

- Enheden er stænkæt, men må dog aldrig nedsænkes i vand.
- Hold enheden ren og tør for at undgå hudirritation.
- Batteriudskiftning må kun udføres i overensstemmelse med anvisningerne. Benyt kun den anbefalede batteritype, som fremgår af denne manual. FORSIGTIG – Der er risiko for eksplosion, hvis batterier udskriftes med batterier af en forkert type. Brugte batterier skal bortskaffes i overensstemmelse med anvisningerne.

Miljøoplysninger

 Dette produkt er i overensstemmelse med kravene i EU-direktiverne 2006/66/EF (Batterier) og 2012/19/EU (WEEE) og bør ikke bortskaffes sammen med husholdningsaffald.

Det anbefales altid at aflevere brugte elektroniske produkter, batterier og emballagematerialer på en genbrugsstation.

Doro AB is a Swedish mobile phone manufacturer. The company was founded in 1989, and is currently owned by the private equity company Permira. Doro AB is a public company listed on the Stockholm Stock Exchange. The company's headquarters are located in the city of Örebro, Sweden. Doro AB is a leading manufacturer of mobile phones in the Nordic region. The company's products are sold in over 100 countries. Doro AB is a member of the Mobile Manufacturers Forum (MMF).

NORSK

EC-samsvarserklæring

Doro AB erklærer med dette at dette utstyret samsvarer med direktivene 1999/5/EC (R&TTE) og 2011/65/EC (RoHS). Den fullstendige teksten i EU-samsvarserklæringen er tilgjengelig på følgende Internett-adresse: www.doro.com/dofc

Produktinformasjon

Produktet er en del av et trygghetsalarmsystem som er ment å iverksette en oppringning i tilfelle en nødsituasjon eller behov for assistanse. Det er ment for innendørs bruk i boligmiljø.

Frekvensbånd: Bluetooth® 2,4-2,4835 GHz, radiofrekvent effekt: maks. 2,5 mW (4 dBm)

Sikkerhetsinformasjon

- Enheten er sprutsikker, men må aldri senkes ned i vann.
- Hold enheten ren og tørr for å unngå hudirritasjon.
- Utskifting av batteri skal bare utføres i samsvar med instruksjonene. Bruk bare anbefalt batteritype ifølge spesifikasjonene i denne håndboken. FORSIKTIG – Eksplosjonsfare hvis batteriet erstattes med batteri av feil type. Kast brukte batterier i henhold til instruksjonene.

Miljøinformasjon

 Dette produktet samsvarer med kravene i EU-direktivet 2006/66/EC (batterier), 2012/19/EU (WEEE), og skal ikke kastes som husholdningsavfall.

Brukte elektroniske produkter, batterier og emballasje skal alltid leveres til egne gjenvinningsstasjoner.

SUOMI

EY-vaatimustenmukaisuusvakuutus

Doro AB vakuuttaa, että tämä laite täyttää direktiivien 1999/5/EY (R&TTE) ja 2011/65/EU (RoHS) vaatimukset. EU-vaatimustenmukaisuusvakuutuksen täydellinen teksti on nähtävillä seuraavassa internetosoitteessa: www.doro.com/dofc

Tuotetiedot

Tämä tuote on osa turvpuhelinjärjestelmää, jonka tarkoituksena on aloittaa puhelu hätätapauksessa tai jos tarvitaan apua. Se on tarkoitettu sisäkäyttöön kotiympäristössä.

Taajuuskaista: Bluetooth® 2,4-2,4835 GHz, radiotaajuuden teho: maks. 2,5 mW (4 dBm)

Turvallisuustiedot

- Laite on roiskeuojattu, mutta sitä ei saa koskaan upottaa veteen.
- Pidä laite puhtaana ja kuivana ihoärsytyksen välttämiseksi.
- Akku on vaihdettava ohjeiden mukaisesti. Käytä vain tässä käyttöohjeessa mainittua, suositeltua akkutyyppiä. VAROITUS – Vääräntyyppisen akun vaihtaminen saattaa aiheuttaa räjähdysvaaran. Hävitä käytetyt akut ohjeiden mukaisesti.

Ympäristötiedot

 Tämä tuote täyttää EU-direktiivien 2006/66/EY (akut) ja 2012/19/EU (WEEE) vaatimukset. Sitä ei saa hävittää muun kotitalousjätteen mukana.

Toimita käytetyt elektroniiikkalaitteet, akut ja pakkausmateriaalit aina kierrätettäviksi niille varattuihin keräyspisteisiin.

Doro AB is a Swedish mobile phone manufacturer. The company was founded in 1989, and is currently owned by the private equity company Permira. Doro AB is a public company listed on the Stockholm Stock Exchange. The company's headquarters are located in the city of Örebro, Sweden. Doro AB is a leading manufacturer of mobile phones in the Nordic region. The company's products are sold in over 100 countries. Doro AB is a member of the Mobile Manufacturers Forum (MMF).

SVENSKA

EG-försäkran om överensstämmelse

Doro AB försäkrar härmed att denna typ av radioutrustning överensstämmer med direktiven 1999/5/EG (R&TTE) och 2011/65/EU (RoHS). Fulltextversionen av EG-försäkran om överensstämmelse finns tillgänglig via följande internetadress: www.doro.com/dofc

Produktinformation

Produkten är en del av ett trygghetslarmsystem för samtalsinitering i händelse av nödsituation eller vid behov av hjälp. Den är avsedd för inomhusbruk i hemmamiljö.

Frekvensband: Bluetooth® 2,4-2,4835 GHz, Radiofrekvenseffekt: max. 2,5mW (4dBm)

Säkerhetsinformation

- Enheten är stänkvattentät, men får aldrig vara nedsänkt i vatten.
- Håll enheten ren och torr för att förhindra hudirritationer.
- Batteribyte kan utföras i enlighet med instruktionerna. Använd endast rekommenderade batteritypen som anges i denna handbok. VARNING! - Risk för explosion om batteriet byts ut mot en felaktig typ. Kassera använda batterier enligt instruktionerna.

Miljöinformation

 Denna produkt uppfyller kraven i EU-direktiv 2006/66/EG (batterier) och 2012/19/EU (WEEE) och får inte kastas tillsammans med annat hushållsavfall.

Återvinn alltid in uttjänta elektroniska produkter, batterier och förpackningar till en återvinningsstation.

Doro AB is a Swedish mobile phone manufacturer. The company was founded in 1989, and is currently owned by the private equity company Permira. Doro AB is a public company listed on the Stockholm Stock Exchange. The company's headquarters are located in the city of Örebro, Sweden. Doro AB is a leading manufacturer of mobile phones in the Nordic region. The company's products are sold in over 100 countries. Doro AB is a member of the Mobile Manufacturers Forum (MMF).